

1.5PL Precision Multi-Line Laser User Guide

Introduction

Thank you for choosing the Spectra Precision® 1.5PL from the Trimble® family of precision products. This simple-to-use tool allows you to perform leveling or vertical plumb work. You can also use the laser outdoors for leveling and aligning applications (optional HR220 receiver required).

Before using the laser, be sure to read this operator's manual carefully. Included in it is information about setting up, using, and maintaining the laser. Also included in this manual are **CAUTIONS** and **Notes**. Each of these words represents a level of danger or concern. A **CAUTION** indicates a hazard or unsafe practice that could result in *minor* injury or property damage. A **Note** indicates important information unrelated to safety.

Your comments and suggestions are welcome; please contact us at:

Trimble Spectra Precision Division
8261 State Route 235
Dayton, Ohio 45424 U.S.A.
Phone: (937) 203-4419
(800) 527-3771
FAX: (937) 482-0030
Internet: www.trimble.com/spectra

Features

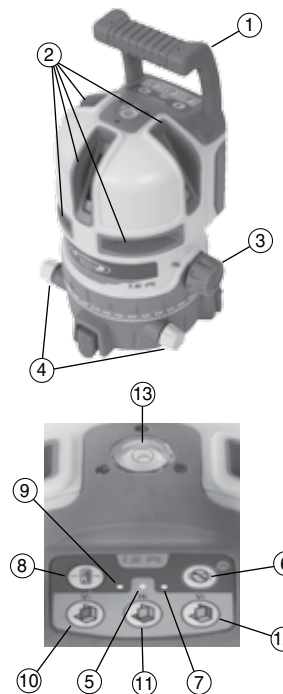

1. Handle
2. Laser Line Exit Windows Horizontal and Vertical
3. Unit ON/OFF Compensator Lock / Manual Mode Knob
4. Fine Alignment Knobs
5. Power On / Low Battery LED
6. Manual Mode Button
7. Manual Mode On LED
8. Receiver Mode Button
9. Receiver Mode On LED
10. Vertical (front) Beam Button
11. Horizontal Beam Button
12. Vertical (left/right) Beams Button
13. Vial (Red/Green)

14. Battery Door Knob
15. Recharge Jack
16. Adjustable Legs

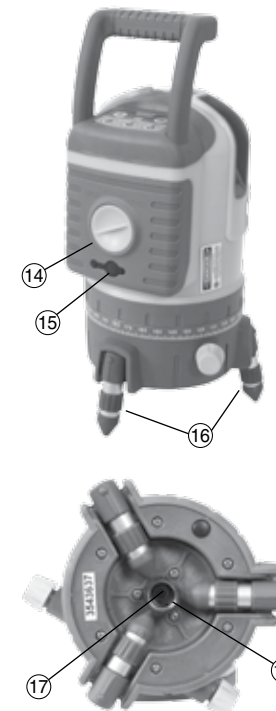

17. Plumb-Down Beam Exit Window
18. 5/8 x 11 Mounting Thread

HR220 Receiver

1. **Power and Audio Button** – turns the receiver ON and OFF and changes the audio to LOUD, LOW or OFF.
2. **Marking Notches** (both sides) – align with the on-grade portion of the photocell and are used to mark elevation readings. The marking notches are 50 mm (2 in.) from the top of the receiver.
3. **Liquid Crystal Display (LCD)** – displays the elevation, power, audio and battery status.
4. **Bubble vials** - aids in keeping receiver level in both horizontal and vertical planes.
5. **Photocell** – detects the laser beam when it strikes the receiver.
6. **Audio Port** – is the opening the sound comes out of.
7. **Clamp-Tab Recess** – is the area that the general-purpose clamp's release tab fits into.

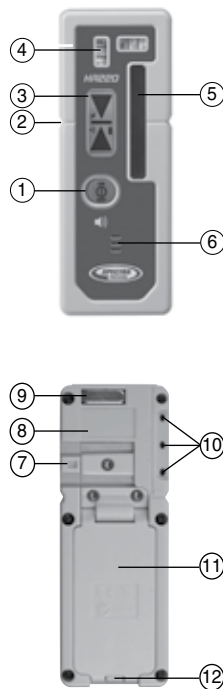

HR220 Receiver (cont.)

8. Label – shows the serial number and manufacturing date.
9. Magnet—holds the receiver on a wall molding, cross-T, runner, etc.
10. LEDs – show the position of the receiver relative to the laser beam (above grade [red], on grade [green] or below grade [blue]).
11. Battery Housing – holds 2 AA alkaline batteries.
12. Battery Door Latch—opens the battery compartment.

General-Purpose Clamp

The C61 clamp allows the receiver to be attached to a survey rod or wooden pole.

1. **Release Tab** – allows the receiver to be locked onto or released from the general-purpose clamp.
2. **Jaws** – close/open so that the general-purpose clamp can be attached to or released from a survey rod or wooden pole.
3. **Jaws Screw** – controls the closing/opening of the jaws.
4. **Reading Edge** – aligns with the receiver's on-grade marking notches.
5. **Bubble Screw Holes** – are where the optional 1277-6251S rod bubble kit is mounted.

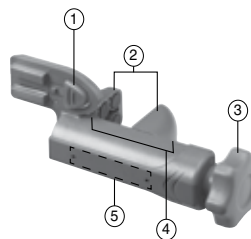

Batteries/Charging

Installation/Removal

CAUTION: The batteries should be removed when storing the laser more than 30 days.



1. Turn the battery door knob counterclockwise to release the battery pack.
2. Install/remove the 4 x AA batteries.
Note: When installing the batteries, be sure to note the positive (+) and negative (-) diagrams molded on the battery housing.
3. Put the battery pack in place and lock it by turning the knob clockwise.

Battery Charger

1. Plug the battery recharger's plug into the laser's battery recharging jack.
2. Plug the battery recharger into the wall outlet.

Note: A full charge will be reached in 4-5 hours.



Basic Operation

1. Unlock the laser's compensator by turning the compensator lock/ unlock knob to the LEFT. The Power On/Low Battery LED illuminates RED and the vial lights GREEN when the unit has been set up inside its self-leveling range.
When the batteries need to be charged/changed the Power On / Low Battery LED flashes RED.

Note: For added mechanism protection always lock the laser when not in use by turning the compensator lock/ unlock knob to the RIGHT.

Automatic Mode

1. Turn the compensator knob to the On-Position- the Power On / Low Battery LED illuminates RED and the vial lights GREEN when the unit has been set up inside its self-leveling range.
2. The beams can be activated/deactivated using the buttons

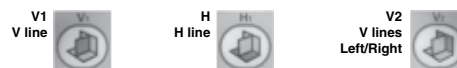

3. When the unit is tilted out of its self-leveling range the vial lights RED, all beams flash and the unit beeps a warning tone.

Manual Mode

1. The laser can be taken out of automatic self-leveling mode to perform slope work by turning the compensator lock/ unlock knob to the RIGHT.
2. Press the MANUAL button. The Power On / Low Battery LED illuminates RED. The Manual LED flashes RED and the vial lights RED.

Receiver Mode

1. To operate the laser with the HR220 receiver press the RECEIVER button. The RECEIVER LED will illuminate RED.

1 M (4 Ft) Marks Using a Tripod

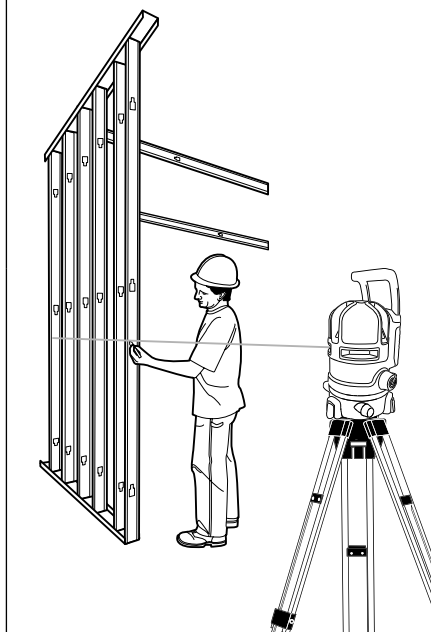

Over Tall Floor Track or Obstacles Using the Extendable Legs

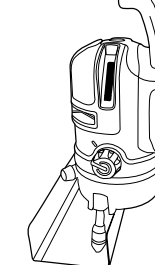

Tile Laying with Angle Alignment

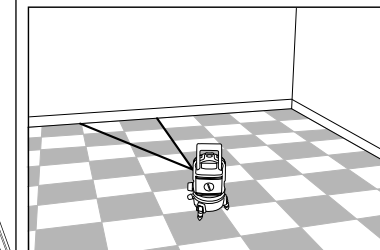

Ceiling with (optional) Wall Mount

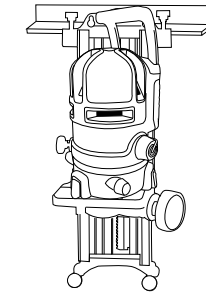

Columns with Mounting Strap

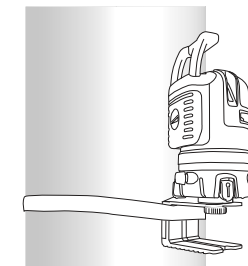

Basic Operation (cont.)

- Note:** The receiver mode can be used in automatic self-leveling and in manual mode.
2. To turn OFF the receiver mode, PRESS the RECEIVER button again.
- To turn OFF the unit and the beams, PRESS the buttons V1, H and V2 again and turn the compensator lock/ unlock knob to the RIGHT.

Applications

General Leveling and Aligning

1. Place the laser on a flat surface. The laser must be level within its self-leveling range.
2. Adjust the position of the lines and plumb point so they are at the desired positions.
3. Mark the position of the wall, elevation, floor or ceiling.

Installing and Plumbing a Wall

1. Place the laser so the Vertical Line Beam is positioned over the desired wall location (usually indicated by 2 floor marks).

Note: If the floor track is already installed the laser should be setup using the extendable legs so the Vertical Line can be positioned over the edge of the track.

2. Use the Vertical Line Beam to position the top track.
3. Use the Vertical Line Beam to position the floor track.



Applications (cont.)

4. To locate the plumb point over a wall corner or other point place the Down Point Beam over the corner or mark. Use the intersecting cross lines to determine the top track corner location.
Note: If the floor track is already installed use the extendable legs to position the Down Point over the corner.

Installing a Ceiling

1. Measure up from the floor (or other reference mark) to the finished ceiling height.
2. Install the first piece of wall molding.
3. Mount the (optional) wall mount with the attached laser to the wall molding.
4. Adjust the elevation of the wall mount slider so that the level beam is at wall molding height. Install the rest of the wall molding.
5. Lower the laser 5 cm (2.0 in.) on the wall mount so that the level beam is at the horizontal target elevation.
6. Install the ceiling's cross Ts and main Ts.

Performing Layout for Angles Other than 90°

1. Set up the unit over the 1st base-line reference point
2. Use the handle to make a rough alignment to the 2nd base-line reference point, then use the fine adjustment knobs for final alignment
3. Use the angle ring to set the 0-mark on the reference line
4. Use the handle to roughly align the unit to the required angle position
5. Use the fine adjustment knobs to adjust the unit until the required angle is positioned exactly above the reference line.

Learning the Receiver Functions

Turning On/Off the Receiver

1. Press the power/audio button to turn on the receiver.

Note: When the receiver is initially turned on/off, all LCD symbols, LEDs, and the audio signal are turned on for one second.

2. Press and hold the power/audio button for one second to turn off the receiver.

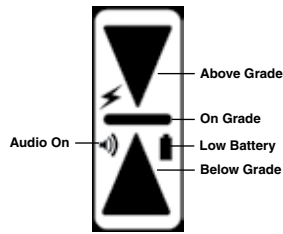

Selecting the Audio Function

The receiver always starts up with the audio mode (loud) active.

1. Press the power/audio button repeatedly to cycle the audio level - loud, low or off.

Note: If the audio function is on, the receiver beeps quickly when the receiver is above the laser beam, slowly when below it, and continuously when centered in the laser beam or on grade.

- 13 -

Laser Setup with a Tripod

1. Set up the tripod in the middle of your work area (or wherever is best for your application needs). Make sure the setup is stable.

Note: The typical operating radius of the system is 75 m (250 ft).

Note: For best system performance, do not set up the laser within 6 m (20 ft) of a wall. Also do not use the receiver within 6 m (20 ft) of the laser or within 1.5 m (5 ft) of a wall. At these close ranges, the receiver's electronics may give incorrect beam elevation information due to the laser beam reflecting off of the walls.

2. Attach the laser directly to a 5/8 x 11 tripod. Use the optional adapter (p/n 0002-3430) for 1/4 x 20 tripods.

3. Turn on the laser and receiver.

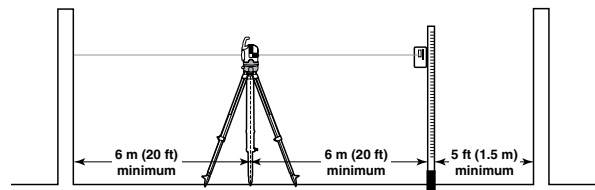

- 17 -

Request for Service

To locate your local dealer or authorized Trimble Service Center outside the U.S.A for service, accessories, or spare parts, contact one of our offices listed below.

North & Latin America

Trimble Spectra
Precision Division
8261 State Route 235
Dayton, Ohio 45424
U.S.A.
(888) 527-3771 (Toll Free)
+1-937-203-4419 Phone
+1-937-482-0030 Fax

Europe

Trimble Kaiserslautern GmbH
Am Sportplatz 5
67661 Kaiserslautern
GERMANY
Tel +49-(0)6301-71 14 14
Fax +49-06301-32213

Africa & Middle East

Trimble Export Middle-East
P.O. Box 17760
Jebel Ali Free Zone, Dubai
UAE
+971-4-881-3005 Phone
+971-4-881-3007 Fax

Asia-Pacific

Trimble Navigation Singapore
PTE Ltd.
80 Marine Parade Road, #22-06
Parkway Parade
Singapore, 449269
+65 6348 2212 Phone
+65 6348 2232 Fax

China

Trimble Beijing
Room 2805-07, Tengda Plaza,
No. 168 Xiwai Street
Haidian District
Beijing, China 100044
+86 10 8857 7575 Phone
+86 10 8857 7161 Fax
www.trimble.com.cn

- 21 -

Using the Receiver with a Laser

1. Press the power/audio button to turn on the receiver. Also make sure the Receiver Mode LED on the 1.5PL laser is RED (if not, press the RECEIVER button on the 1.5PL).

2. Position the receiver so that its photocell faces the laser.

3. Move the receiver up/down until the LCD and LEDs show an on-grade reading.

Note: The LCD shows a down arrow when the receiver is above the laser beam, an up arrow when below it, and a horizontal line when centered in the laser beam. The LED is red for above grade, green for on grade, and blue for below grade.

- 14 -

Determining the Height of Instrument (HI)

The height of instrument (HI) is the elevation of the laser's beam. The HI is determined by adding the grade-rod reading to a benchmark or known elevation.

1. Set up and level the laser.
2. Attach the receiver to a grade rod and turn on the receiver.
3. Place the grade rod on a job-site benchmark (BM) or known elevation.
4. Slide the receiver up/down the grade rod until the LCD shows an on-grade reading.

5. Add the grade-rod reading to the benchmark to determine the height of instrument.

Example: Benchmark elevation = 30.55 m (100.23 ft)
On-grade rod reading = + 1.32 m (4.34 ft)
Height of instrument = 31.87 m (104.57 ft)

6. Use this HI as a reference for all other elevations.

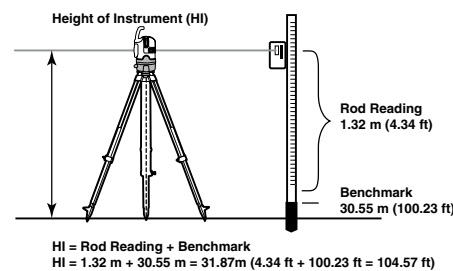

- 18 -

Maintenance and Care

Handling Precautions

When transferring the laser from a very low temperature to a warmer environment or visa versa, always allow time for the laser to reach the new temperature before using. Allowing this time is especially important when transferring the laser from an extremely heated/cold vehicle to the job site.

System Cleaning

For maximum performance and accuracy always keep the windows clean. When cleaning, apply very light pressure and use only a good quality glass cleaner on a soft cloth to clean the exterior of the laser and its windows.

CAUTION: A dry cloth or abrasive organic cleaner could scratch or damage these surfaces.

CAUTION: Do not submerge the laser.

Storage

When you're not using the laser, store it in its pouch/carrying case.

CAUTION: Do not store the laser in a wet pouch/carrying case. If the pouch/carrying case gets wet, let it dry before storing the laser in it.

Calibration

Before each use, be sure to check the laser for signs of damage. If the laser has been dropped or subjected to other rough treatment, it should be checked for accuracy. For instruction on checking calibration, please visit our website support list at www.trimble.com/support.shtml

- 22 -

LCD/LED/Audio Information

LCD Readout	Function	Audio Output	LED Indication
Down arrow ▼	High	Fast beeping tone	Top red LED: solid
Center bar & down arrow ▼	Fine-high	Fast beeping tone	Top red LED: flashing
Center bar —	On-grade	Continuous tone	Middle green LED: solid
Center bar & up arrow ▲	Fine-low	Slow beeping tone	Bottom blue LED: flashing
Up arrow ▲	Low	Slow beeping tone	Bottom blue LED: solid
			LCD Indication
Battery 🔋	Low battery	N/A	Flashing symbol
Horn 📢	Audio Loud	Loud	Solid symbol
	Audio Low	Low	Flashing symbol
	Audio Off	None	No symbol

- 15 -

Specifications

Laser

Horizontal and Vertical Lines ^{1,2}	± 1.0 mm @ 5 m (± 1/32 in. @ 17 ft)
Down Point Beam Accuracy ^{1,2}	± 0.4 mm @ 1 m (± 1/32 in @ 3 ft)
Self-Leveling Range	± 3° from level
Out-of-Level Indicator	Beam Flashes, Vial lights RED and Beeping Warning Tone
Visual Working Range	30 m (100 ft)
Manual Mode and Compensator Lock Indicator	LED On and Vial lights RED
Laser Class / Type	2 / 635 nm
Line Beams Fan Angle	200° Horizontal / 120° Vertical (200°+ total of both lines)
Power Source	NiMH-recharge pack + backup 4 AA alkaline
Battery Life ¹	> 7 hours. All beams on (NiMH/alkaline)
Low-Battery Indicator	POWER LED flashes RED
Operating Temperature Range	-10 °C to 45 °C (14 °F to 113 °F)
Size	H24.0 x W13.8 x D12.1 cm (9.45 x 5.4 x 4.77 in)
Weight (Transmitter w/ Batteries)	1.54 kg (3.39 lbs)

¹) at 21° C (70° F)

²) along the axis

- 19 -

Warranty

Trimble warrants the 1.5PL to be free of defects in material and workmanship for a period of one year. Trimble or its authorized Dealer or service center will repair or replace, at its option, any defective part, or the entire product, for which notice has been given during the warranty period. This warranty period is in effect from the date the system is delivered by Trimble or its authorized Dealer to the purchaser, or is put into service by a Dealer as a demonstrator or rental component.

Customers should send products to the nearest Authorized Factory, Dealer, or Service Center for warranty repairs, freight prepaid. In countries with Trimble Service Subsidiary Centers, the repaired products will be returned to the customer, freight prepaid.

Any evidence of negligent, abnormal use, accident, or any attempt to repair equipment by other than factory-authorized personnel Trimble certified or recommended parts, automatically voids the warranty.

Special precautions have been taken to ensure the calibration of the laser; however, calibration is not covered by this warranty. Maintenance of the calibration is the responsibility of the user.

The foregoing states the entire liability of Trimble regarding the purchase and use of its equipment. Trimble will not be held responsible for any consequential loss or damage of any kind.

This warranty is in lieu of all other warranties, except as set forth above, including an implied warranty merchantability of fitness for a particular purpose, is hereby disclaimed. This warranty is in lieu of all other warranties, expressed or implied.

- 23 -

Attaching the Receiver to a Grade Rod

1. Slide the general-purpose clamp into the receiver until it "clicks" into position.
2. Turn the jaws screw counterclockwise to open the clamp's jaws.
3. Slide the survey rod or wooden pole between the clamp's jaws.
4. Turn the jaws screw clockwise to hold the general-purpose clamp securely in place.

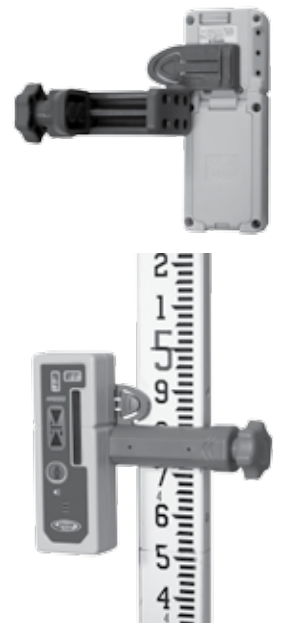

- 16 -

Receiver

Accuracy	±1.0 mm (±1/32 in.)
Elevation Readout	Front LCD and simultaneous rear corner LEDs (red, green, and blue)
Audio Control	Loud / Low / Off
Capture Height	50 mm (2 in.)
Marking Notches	50 mm (2 in.) below top of receiver
Power Source	2 AA alkaline batteries
Battery Life	50+ hours
Low-Battery Indicator	Flashing battery symbol on LCD
Automatic Shutoff	30 minutes after last laser strike or button press
Drop Resistance	1.5 m (5 ft) onto concrete at room temperature
Water Proof / Dust Proof	Yes - IP67
Operating Temperature	-20 °C to 60 °C (-4 °F to 140 °F)
Storage Temperature	-40 °C to 70 °C (-40 °F to 158 °F)
Regulatory Conformance	2004/108/EC; 2002/95/EC; 2002/96/EC

Notice to Our European Union Customers

For product recycling instructions and more information, please go to: www.trimble.com/environment/summary.html

Recycling in Europe

To recycle Trimble WEEE, call: +31 497 53 2430, and ask for the "WEEE associate," or mail a request for recycling instructions to:
Trimble Europe BV
c/o Mento Worldwide Logistics
Meerheide 45
5521 DZ Eersel, NL



- 20 -

Laser Safety

Use of this product by people other than those trained on this product may result in exposure to hazardous laser light.

- Do not remove warning labels from the unit.
- The 1.5PL is a Class 2 (635 nm) laser.
- Never look into the laser beam or direct it to the eyes of other people.
- Always operate the unit in a way that prevents the beam from getting into people's eyes.



Trimble Spectra Precision Division
8261 State Route 235
Dayton, Ohio 45424-6383
U.S.A.

www.trimble.com/spectra



© 2011, Trimble Navigation Limited. All rights reserved.
Reorder PN 1213-0803 Rev B (12/11)

- 21 -

- 22 -

- 23 -