

Specifications

Working Radius:	1 m - 400 m (3 ft - 1300 ft) (Laser dependent):		
Laser Detection Height:	102 mm (4")		
Numeric Readout Height:	76 mm (3")		
Accuracy (Dead band):			
Fine	1.0 mm	0.05 in	1/16 in
Medium	5.0 mm	0.20 in	1/4 in
Calibration	0.1 mm	0.01 in	1/64 in
Reception Angle:	± 45° minimum		
Detectable Spectrum:	610 nm ... 900 nm		
Beeper Volumes:	Loud = 100+ dBA Low = 65 dBA		
Power Supply:	2 x 1.5 Volt "AA" batteries		
Battery Life:	70+ hours		
Automatic Shut Off:	30 min		
Environmental:	Waterproof, Dustproof to IP67		
Weight without clamp:	371 g (13.1 oz.)		
Dimensions without clamp:	168.0 x 76.0 x 36.0 mm (6.6" x 3.0" x 1.4")		
Operating Temperature:	-20°C...+60°C (-4°F... +140°F)		
Storage Temperature:	-40°C...+70°C (-40°F...+158°F)		

*Specifications subject to change without notice.

Warranty

Trimble warrants the HL450 to be free of defects in material and workmanship for a period of three years. Trimble or its authorized service center will repair or replace, at its option, any defective part, or the entire product, for which notice has been given during the warranty period. If required, travel and per diem expenses to and from the place where repairs are made will be charged to the customer at the prevailing rates. Customers should send the product to Trimble or the nearest authorized service center for warranty repairs or exchange, freight prepaid. Any evidence of negligent, abnormal use, accident, or any attempt to repair the product by other than factory-authorized personnel using Trimble certified or recommended parts, automatically voids the warranty. The foregoing states the entire liability of Trimble regarding the purchase and use of its equipment. Trimble will not be held responsible for any consequential loss or damage of any kind. This warranty is in lieu of all other warranties, except as set forth above, including any implied warranty merchantability of fitness for a particular purpose, are hereby disclaimed. This warranty is in lieu of all other warranties, expressed or implied.

Notice to Our European Union Customers

For product recycling instructions and more information, please go to: www.trimble.com/environment/summary.html

Recycling in Europe

To recycle Trimble WEEE, call: +31 497 53 2430, and ask for the "WEEE associate," or



Mail a request for recycling instructions to:
Trimble Europe BV c/o Menlo Worldwide Logistics
Meerheide 45 5521 DZ Eersel, NL



Trimble - Precision Tools
5475 Kellenburger Road
Dayton, Ohio 45424-1099
U.S.A.
+1-937-245-5600 Phone
Toll Free USA 1-888-527-3771

www.spectralasers.com



© 2019, Trimble Inc. All rights reserved.
Reorder PN 1277-3965B (10/19)

HL450 Digital Readout Receiver

User Guide



www.spectralasers.com

EMC Declaration of Conformity

This receiver has been tested and found to comply with the limits for a Class B digital device for radio noise for digital apparatus set out in the Radio Interference Regulations of the Canadian Department of Communication, and is pursuant to part 15 of the Federal Communication Commission (FCC) rules. These limits are designed to provide reasonable protection against harmful interference in a residential installation. This receiver generates radio frequency. If it's not used in accordance with the instructions, it may cause harmful interference to radio or television reception. Such interference can be determined by turning the receiver off and on. You are encouraged to try eliminating the interference by one or more of the following measures:

- Reorient or relocate the receiving antenna.
 - Increase the separation between the laser and the receiver.
- For more information, consult your dealer or an experience radio/television technician.

CAUTION: Changes or modifications to the receiver that are not expressly approved by Trimble could void authority to use the equipment.

Declaration of Conformity

Application of Council Directive(s):	89/336/EEC
Manufacturer's Name:	Trimble Inc.
Manufacturer's Address:	5475 Kellenburger Road Dayton, Ohio 45424-1099 U.S.A.
European Representative Address:	Trimble GmbH Am Prime Parc 11 65479 Raunheim, Germany
Model Number:	HL450
Conformance to Directive(s):	EC Directive 89/336/EEC using EN55022 and EN50082-1
Equipment Type/Environment:	ITE/residential, commercial & light industrial
Product Standards:	Product meets the limit B and methods of EN55022 Product meets the levels and methods of IEC 801-2, 8 kV air, 4 kV contact IEC 801-3, 3 V/m 26 to 1000 MHz 80%, @ 1 kHz

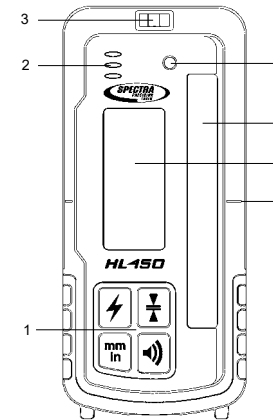

Front view

1. Keypad - Power, Accuracy, Units & Volume switches.
2. Beeper output - Fast, solid & slow audible signal.
3. Bubble Vial - aids in keeping HL450 level.
4. Anti-strobe sensor - Reduces false indication from strobe lights.
5. SuperCell Reception Window - 4.0 in / 102 mm of height.
6. Front LCD - Displays elevation, settings and status.
7. On-grade Mark - Aligned with laser center on-grade reading.

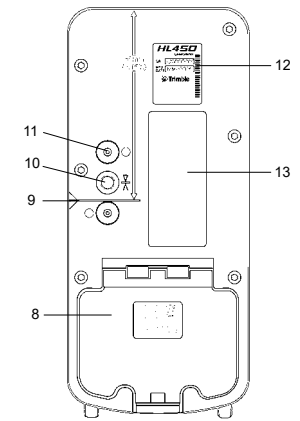

Rear view

8. Battery Door & Latch for two "AA" batteries.
9. Marking Notch (3.15 in / 80.0 mm from top).
10. Captive Screw Thread
11. Clamp Guides - Dimples align rod clamp.
12. Serial Number / ID Label.
13. Rear LCD - repeats indications of front LCD.

Installing the Batteries

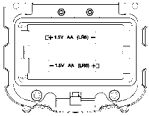

1. Open the battery door using a coin or similar pry device to release the battery door tab.
2. Insert two AA batteries noting the plus (+) and minus (-) diagrams inside the battery housing.
3. Close the battery door. Push down until it "clicks" into the locked position.

Battery Status

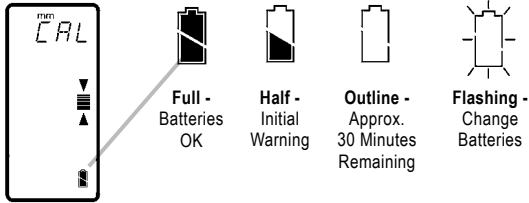

Rod Clamp

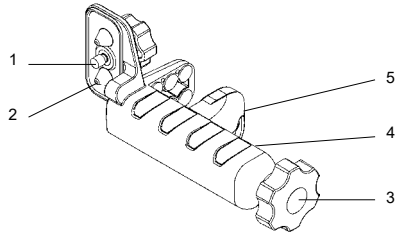

1. Captive Rod Clamp Screw - attaches to the back of detector.
2. Alignment Points (2) - help secure and align rod clamp.
3. Clamping Screw Knob - secures clamp to rods by moving the traveling jaw. Clockwise tightens; Counterclockwise loosens.
4. Reference Bar - top of bar is aligned with on-grade.
5. Traveling Jaw - moving jaw grips tightly to rods.

Action

Turn power ON/OFF

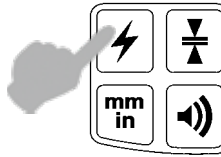

Press to turn power ON. Press and hold for 2 seconds to turn power OFF.

Select accuracy

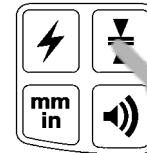

Press once to display current setting; push again to scroll through options.

Select beeper volume

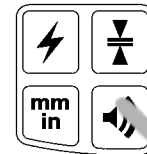

Press once to change current setting (A beep confirms the selected volume.)

Select units of measure

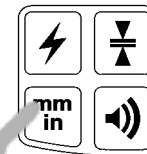

Press once to display current setting, additional pushes to scroll through options.

Display

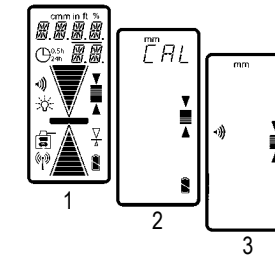

Remarks

- Initialization:
1. Test of LCD and beeper
 2. CAL: Calibration (3 sec.)
 3. Unit is ready for use.
- (Do not power up the unit in a laser beam or strobe. If detected, the unit will display "E200" and revert to the previous calibration.)

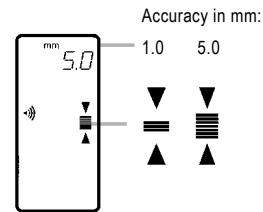

- The selected unit of measure determines the displayed deadband (accuracy).
- The current accuracy is stored in memory and will be retained when the unit is turned off or when batteries are replaced.

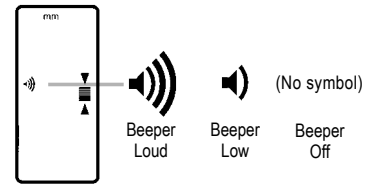

- The current beeper volume is stored in memory and will be retained when the unit is turned off or when batteries are replaced.

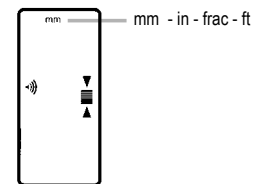

- The current unit of measure is stored in memory and will be retained when the unit is turned off or when batteries are replaced.